

MELT QUALITY CONTROL AT ALUMINUM CASTING PLANTS

Mile B. Djurdjević^{1*}, Zoran Odanović², Jelena Pavlović-Krstić³

¹*Nemak Linz, Zeppelinstrasse 24, 4030 Linz, Austria*

²*IMS Institute, Bulevar vojvode Mišića 43, 11000 Belgrade, Serbia*

³*Institute of Manufacturing Technologies and Quality Assurance, University of Magdeburg, Universitätsplatz 2, Magdeburg, 39106, Germany*

Received 28.02.2010

Accepted 27.03.2010.

Abstract

Control of the quality of the product normally begins with the control of the quality of the melt. A complete understanding of melt quality is of a great importance for the control and prediction of actual casting characteristics. If one is able to act in a proactive rather than a reactive manner in respect to melt and casting quality control, one can reduce cost downtime and scraps levels. There is no a unique apparatus on the market available for complete assessment of aluminum melt quality. Therefore, apparatus combining several methods such as: thermal analysis, reduced pressure test, K-mold, Tatur test, fluidity spiral test and PoDFA have to be used for complete evaluation of the aluminum melt quality. This paper will review all above mentioned apparatus and introduces two new apparatus Alspek H and Alspek MQ, recently developed by Foseco Company.

Key words: quality control, aluminum alloys, casting



Introduction





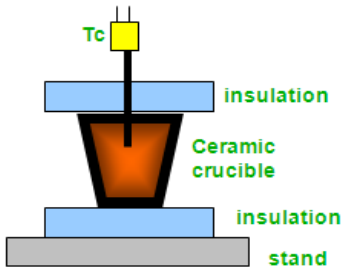
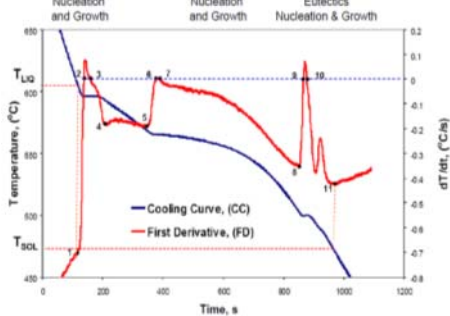
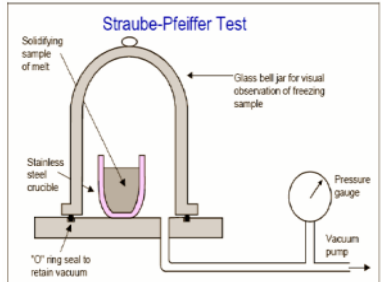

Aluminum casting plants are using significant amounts of primary, secondary and master alloys in order to produce automotive parts of high quality. The quality of cast products directly depends on the quality of molten metal from which the products are cast. Comprehensive understanding of the melt quality is of vital importance for the control and prediction of actual casting characteristics. Any defect added or created during the melting stage will be carried to the final microstructure, and certainly, affect the quality of cast products. Therefore it is apparent that the control of the quality of the cast products begins with the control of the quality of the melt.

* Corresponding author: Mile B. Djurdjević Mile.Djurdjevic@nemak.com

There is no unique apparatus on the market that can be use for comprehensive qualitative assessment of aluminum melt. Therefore, combinations of several equipments have to be used for complete evaluation of the aluminum melt quality. The most common tools used in aluminum casting plants are as follows: (i) Thermal (cooling curve) analysis, (ii) Reduced pressure test, (iii) K-mold, (iv) Tatur test, (v) Spiral test, (vi) Alscan for hydrogen measurements, and (vii) Prefil or PoDFA apparatus. Aluminum casting plants use for daily melt quality control at least one above mentioned apparatus. This paper will review all above mentioned equipments and highlights their applications. In addition, two new equipments recently developed by Foseco Company will be presented: AlspekH for on-line measurement of hydrogen solubility in the aluminum melt, and Alspek MQ for melt cleanliness assessment. Table 1 summarizes all previously mentioned equipments and their main characteristics. Using daily these equipments substantial gains can be made in reduction of machining defects, increased mechanical properties, reduced porosity and overall scrap reduction.

Table 1. Review of the main tools used in casting plant to determine the quality of aluminum melt

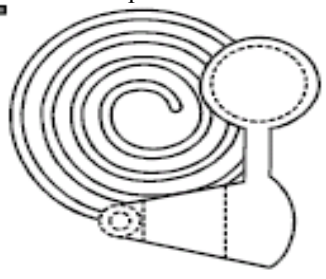
Equipments	Observed characteristics
<p data-bbox="459 981 649 1010">Thermal analysis</p> 	<p data-bbox="821 981 1201 1010">Cooling Curve (CC) and its First Derivative (FD)</p> 
<p data-bbox="422 1361 1173 1422"><i>Applications:</i> Characterize the solidification path of aluminum alloys; Control the efficiency of master alloys additions into aluminum melts</p>	
<p data-bbox="438 1422 678 1451">Reduced pressure test</p> 	
<p data-bbox="486 1742 1109 1800"><i>Applications:</i> Quality control of molten aluminum melts; Control efficiency of degassing units</p>	

<p style="text-align: center;">K-Mold</p> 	
<p><i>Applications:</i> Quantitative and qualitative assessment of aluminum melt macro cleanliness; K mold value (K) expresses the cleanliness of aluminum melt and depends on the number of oxide films $K = S/n$</p>	
<p style="text-align: center;">Tatur test</p> 	
<p><i>Applications:</i> Semi qualitative test for shrinkage and porosity distribution as a function of: (i) Hydrogen concentration, (ii) Alloy solidification mode and (iii) Melt cleanliness</p>	
<p style="text-align: center;">Spiral test</p> 	
<p><i>Applications:</i> Measurements of alloys fluidity</p>	

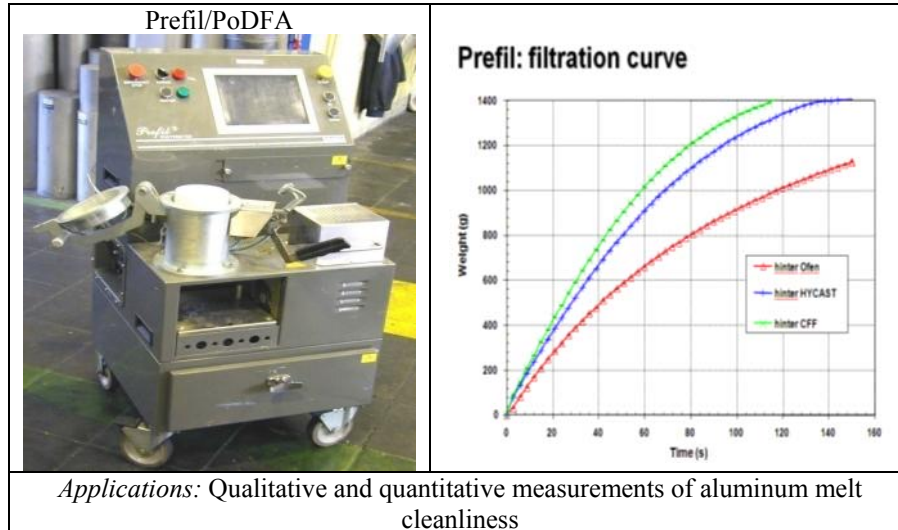

Thermal Analysis

The solidification process of a metal or alloy is accompanied by the evolution of heat of various phases formed during the solidification. Recorded temperature-time data can yield quantitative information about the alloy solidification process. Such a plot is called a cooling curve and the general name given to the technique is thermal analysis (TA).

The cooling curve serves as a “finger print” of the solidification process and can be used to predict the structure of the test sample and consequently the actual casting properties. This paper will briefly review the application of TA in aluminum casting plants, showing its ability to predict some key solidification parameters, which, can be used to monitor the quality of cast products.

In the aluminum casting industry, the application of TA to study the development of the test sample structure was reported in early publications by Cibula [1] and Mondolfo [2]. In the early 1980's, this process control technology started to be regularly used in aluminum foundries. The TA test samples can be taken either by submerging a cylindrical (graphite ceramic or steel) cup into the melt or pouring the melt by ladle into test cup. One or two K-type thermo elements have been placed into the melt to measure the temperature during solidification of test sample. The outputs from the thermocouples were connected to a PC via data logger, where temperature/time data were recorded and later processed in various ways. At present, aluminum casting plants are regularly using TA to control the efficiency of master alloys additions (grain refiner and modifier) into the aluminum melt.

Assessment of grain size

Grain refinement obtained during solidification can be a function of undercooling occurring during the liquidus arrest. The shape of the cooling curve at the

beginning of the solidification process gives a good indication of the number of nuclei present in the melt. When there are a great number of nuclei, the curve exhibits low undercooling, (as illustrated in Fig. 1 by the dotted line). When there are few nuclei, a higher extent of undercooling may be expected, which is illustrated in the Fig. 1 by the solid line.

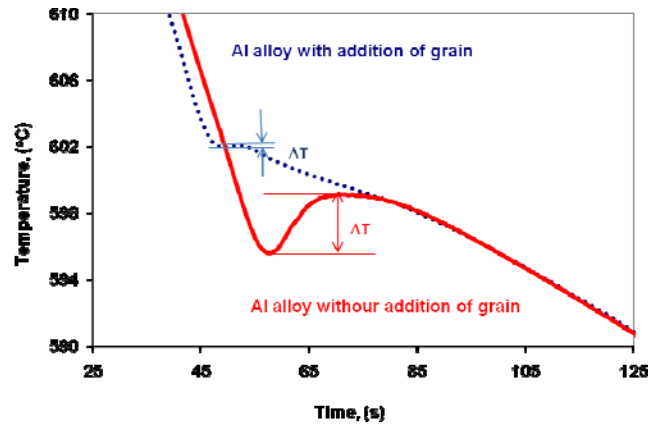

Fig. 1. Part of the cooling curve related to the primary solidification of aluminum alloys.

Undercooling parameter from the cooling curve has been routinely used for the quality process control giving a prompt information about efficiency of grain refining additions into aluminum melt. Smaller ΔT parameter, means higher potency of master alloys leading to smaller casting grains in as-cast structure. The ability to closely control the grain size is of the major importance to solving casting problems on the foundry floor. The use of grain refiners results in multiple improvements of the final casting characteristics. These include: (i) improved mechanical properties, reduced hot-tearing, improved response to heat treatment, improved feeding of castings which results in reduced shrinkage porosity.

Modification of Al-Si eutectic morphology

The term “modification” describes the condition of refinement of the silicon particles. The modifying effect is the transition from blocky, acicular and needle-like silicon phases to a fine fibrous silicon structure. This substantially improves the casting properties of Al-Si alloys.

TA technique can be used to determine the Al-Si eutectic morphology before and after the addition of modifiers. The net effect of the additions of modifiers on the cooling curve of Al-Si alloys is the depression of the nucleation and growth temperatures of main eutectic reaction [3-10]. Fig. 2, shows the effect of modification on the Al-Si eutectic growth temperature ($T_{E,G}^{Al-Si}$).

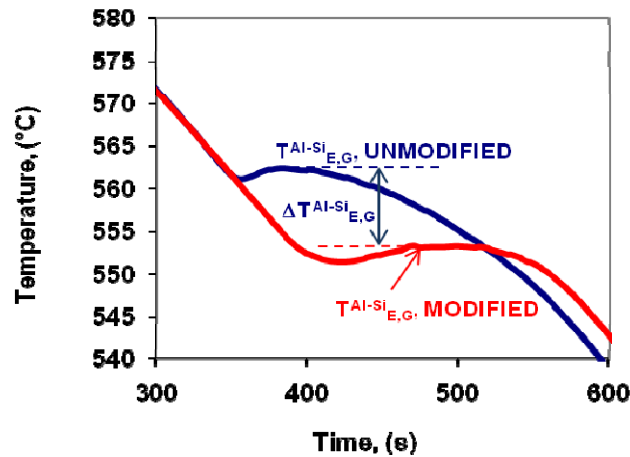

Fig. 2. Part of the cooling curve related to Al-Si eutectic region

The depression of $\Delta T_{E,G}^{Al-Si}$ represents the temperature difference between the unmodified and modified Al-Si eutectic growth temperatures. The larger the magnitude of $\Delta T_{E,G}^{Al-Si}$ the higher the level of modification (smaller size of silicon particles).

TA is daily used in aluminum casting plants to evaluate parameters such as grain size and the level of Al-Si eutectic modification. The use of modern data acquisition systems and computer processing thermal analysis become a powerful tool for casting process control. Thermal analysis can provide process engineers with the ability to act in a proactive manner in respect to melt and casting quality. Potential application of TA as a real time statistical quality control tool in aluminum casting plants is not yet realized. A state-of-the-art TA system should be able to quantify parameters such as: grain size, dendrite coherency point, level of silicon modification, low melting temperature of secondary eutectic, precipitation of iron-bearing intermetallics, precipitation of magnesium intermetallics, fraction solid and other characteristic temperatures such as: T_{LIQ} , $T_{E,G}^{AlSi}$, $T_{E,G}^{AlCu}$ and T_{SOL} , i.e. liquidus, Al-Si eutectic, Al-Cu eutectic and solidus temperature, respectively.

Reduced pressure test

The reduced pressure test is a foundry floor tool which allows the operator to qualitatively assess the cleanliness of a batch of molten aluminum, allowing corrective action to be followed.

The main principle of this technique is based on the formation of gas porosity when liquid aluminum is cooled under the reduced pressure. The size of the porosity formed is magnified by the effect of the reduced pressure, resulting in a visibly porous sample as shown in Fig. 3. The samples solidified under these conditions are evaluated either by visual observation for bubble formation during solidification, or by

determining the density of the solidified sample. Visual evaluation of the sectioned sample is often done by comparing the result to a standard chart.

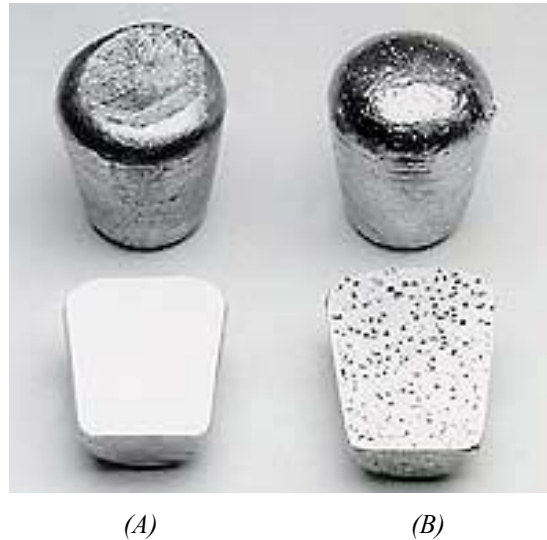

Fig. 3. Test samples (A) solidified under atmospheric pressure and (B) solidified under vacuum.

The sampling procedure is very simple. A small amount, about 200 g., of aluminum melt is poured into two thin wall steel crucibles. One crucible is leaved to solidify under atmospheric pressure while other is seated in the chamber, where the pressure is reduced to 80 mbar and remains constant until the melt is fully solidified. After solidification, the samples are removed from the molds and evaluated either by density measurement or by sectioning to observe the porosity. The entire process requires roughly several minutes for completion.

Density index (DI) has been calculated using following equation (1):

$$DI = ((\sigma_A - \sigma_B) / \sigma_A) \times 100 \quad (1)$$

Where:

σ_A – density of test sample solidified under atmospheric pressure

σ_B – density of test sample solidified under reduced pressure

This test is quite popular and is widely used by hundreds of foundries worldwide.

K–mold

K- mold device is a fracture test invented by Sanji Kitaoka in Japan in 1973, at Nippon Light Metal Ltd company. More than forty years this device has been used as a simple shop floor equipment. The purpose of this equipment is to evaluate the macro

cleanliness of molten aluminum melt at production conditions. The main advantages of this equipments are: (i) quick evaluation (approximately 10 min), (ii) easy handling, (iii) easy sampling and melt cleanliness assessment; (iv) portable, (v) sensitive to the inclusions and oxide film, (vi) costly friendly, and (vii) appropriately accurate.



Fig. 4. K-mold

Experimental procedure is very simple. Around 400 g of the melt is poured into the preheated mold and after a few seconds test samples like flat bars (240x36x6mm) are obtained.

The test samples need to be broken into several pieces and put together as shown in Fig. 5. The fracture surfaces have been analyzed either visually or under a low magnification. Rapid solidification of the sample produces very fine matrix, and thus inclusions are clearly detected on the fracture surface.



Fig. 5. Fractured pieces of K-mold test sample.

The cleanliness of the melt is expressed through K-mold value. This value is based on the visual inspection of the surface of the test pieces and count of the number of the inclusions on the surface for the evaluation of the cleanliness of the melt.

$$\text{K mold value: } K = S/n$$

K – number of inclusions found in one piece of a sample within fracture surface

S – total number of inclusions found in n-pieces of the small probe

n – number of examined samples.

Every casting plant need to establish its own scale/range for each product based on K-mold values (lower K mold value means cleaner melt).

Tatur test

Tatur test has been developed by A. Tatur in order to measure affinity of alloys to build up macro and micro porosity during solidification. Unfortunately, this test has been rarely used in aluminum casting plants as a routine quality control tool. The main reason for that could be an extra work necessary for full evaluation of the melt cleanliness.

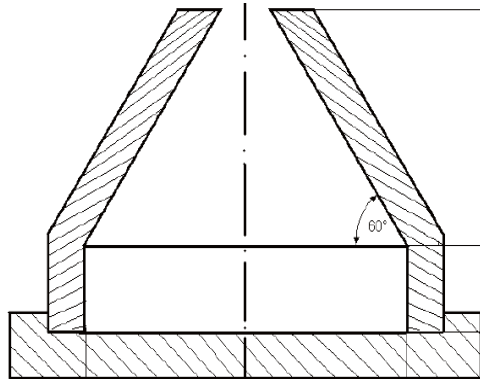

Fig. 6. Schematic presentation of Tatur probe

Fig. 6 graphically presents the form of Tatur probe, which has been designed to promote the formation of shrinkage porosity. The Tatur test utilizes a permanent mold of fixed geometry containing two parts. The upper part is conic with orifice. During experiment the melt is poured through the preheated mold orifice and allowed to solidify without extra addition of the melt. Due to contraction during liquid-solid transformation, conic design of upper part and absence of riser, the formation of micro and macro porosity will be enhanced. By using simple techniques such as the density measurement and water displacement, it is possible to quantify the volume of micro and macro shrinkage and contraction. In order to draw reliable conclusions, it is necessary to perform a large number (about 20) of tests and to evaluate them statistically. The low

reproducibility of the measurements is additional reason why this technique has not been widely used at foundry floor as a quality control tool.

Fig. 7 shows some typical micro and macro porosity forms achieved using Tatur test.



Fig. 7. Typical shrinkage porosity obtained using Tatur test.

Spiral test

Fluidity is a very important property of any melt which directly affects the quality of final cast products. Several methods have been developed to measure the ability of melts to flow through the gating system, fill the mould cavity and produce a desired shape. Traditionally, fluidity has been measured in a spiral mold. Fig. 8 shows tools used to measure the fluidity of the metal and alloys.

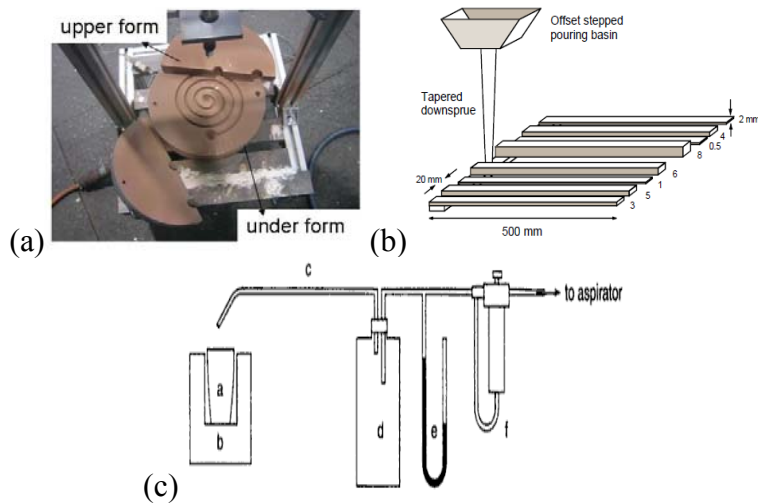

Fig. 8. Measurement of fluidity using Spiral test (a), new test developed at The University of Birmingham, UK (b), and vacuum (Ragone) test (c).

At the present time, two fluidity tests are mostly used at aluminum casting plants: spiral test and vacuum or Ragone test. Although widely used, they are also widely criticized for a number of reasons. The most important reason is the low reproducibility of fluidity test. The fluidity of metals is affected by many parameters such as: metal variables (chemical composition and solidification range), mold and mold/metal variables (coating and thermal conductivity) and test variables (superheat oxide content). Therefore, it is difficult to keep all these parameters under control in various experiments. In order to increase the reproducibility of measurements, many of the above mentioned parameters need to be controlled during experiments.

PoDFA/Prefil test

PoDFA (Porous Disc Filtration Apparatus) and its successor Prefil are equipments used for qualitative and quantitative evaluation of the melt cleanliness. The PoDFA test has been first developed with the main aim to evaluate the metal cleanliness using metallographic examination of the test filter [11-12]. A small quantity of melt (~2 kg) flows under the pressure through a very fine porous test filter. Inclusions concentrated on the surface of the test filter are analyzed using light optical or/and scanning electron microscope. Type and the size of inclusions and oxides should be identified by an expert. Fig. 9 shows a schematic principle of operation using PoDFA apparatus.

Working principle of Prefil test is the same as previously described for PoDFA test. Throughout the test, the system continuously weighs the metal in the weight ladle and displays a curve of the accumulated weight versus the elapsed time [13].

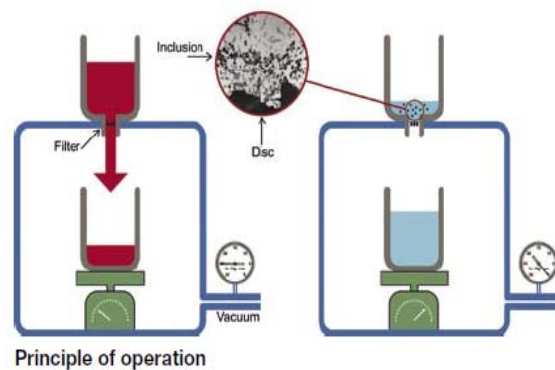

Fig. 9. Principle of operation using PoDFA apparatus

The cleaner the metal, the higher this curve will be; inclusions in the metal, such as oxide films, quickly build-up on the filter surface during the test, reducing the flow-rate through the filter. The slope and overall shape of the weight filtered versus time curve indicates the level of inclusions present in the metal. The metal residue above the filter can be saved for supplementary metallographic analysis. The operating principle is illustrated in Fig. 10.

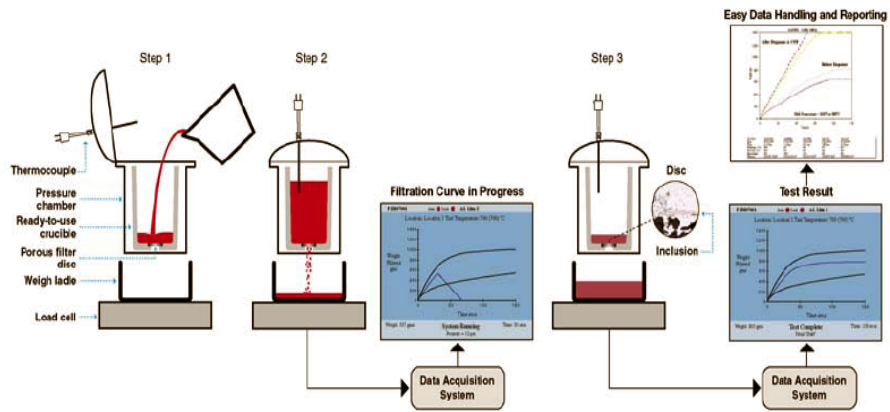

Fig. 10. Prefil operation principle [13]

New devices for melt quality control (Foseco)

To be suitable for foundry applications, a device for measuring the hydrogen content in liquid aluminum has to meet a number of particular requirements such as: (i) short response time, (ii) reliable values, (iii) reproducible results, (iv) long life in foundry environment and (v) simple handling. Recently developed device by Foseco Company, named ALSPEK H hydrogen analyzer [14, 15] fulfils all these requirements and enables foundrymen to control the hydrogen content before, during and after the degassing process.

Table 2. Foseco devices recently developed for assessment melt quality control

<p style="text-align: center;">Alspek H</p>	
<p>Sensor for real time rapid measurement of dissolved hydrogen into aluminum melt</p>	

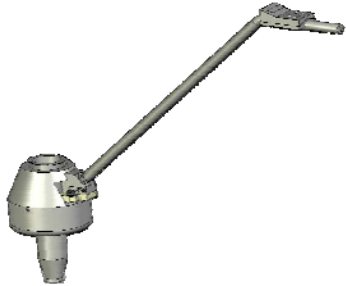
<p>Alspek MQ</p> 	<table border="1"> <thead> <tr> <th>Melt Quality Index, MQI</th> <th>Comments</th> </tr> </thead> <tbody> <tr> <td>MQI 7 – 9</td> <td>Extremely dirty</td> </tr> <tr> <td>MQI 4 – 6</td> <td>dirty</td> </tr> <tr> <td>MQI 1 – 3</td> <td>clean</td> </tr> </tbody> </table>	Melt Quality Index, MQI	Comments	MQI 7 – 9	Extremely dirty	MQI 4 – 6	dirty	MQI 1 – 3	clean
Melt Quality Index, MQI	Comments								
MQI 7 – 9	Extremely dirty								
MQI 4 – 6	dirty								
MQI 1 – 3	clean								
<p>Rapid test for monitoring the cleanliness of aluminum melt</p>									

The ease of use of ALSPEK H means that it can readily be used to measure melt quality in different locations around the foundry. Fast and accurate spot measurements of hydrogen concentrations can be performed in ladles and furnaces, or the probe can be left immersed in one location to provide continuous real time measurement of hydrogen levels. It is also possible to carry out a real time hydrogen measurements during a degassing treatment. All measured values are automatically logged and can be downloaded later to provide important data for quality control and certification purposes. So far there is not such equipment on the market that can on line measure the variation of the hydrogen solubility in aluminum melt.

ALSPEK MQ is another product developed at Foseco Company aimed at offering the foundry a practical, simple, rapid and meaningful method of measuring and bench marking melt cleanliness. The principle behind ALSPEK MQ is the ability of a fine foam filter to trap non-metallic inclusions. Foam filters are multi-dimensional where the metal must follow a tortuous path in order to pass through. Larger particles are trapped on the face of the filter thereby restricting the flow of the subsequently flowing metal. The internal random structure of the filter encourages changes in metal flow direction and metal velocity causing smaller inclusions to become trapped in the internal structure. The principle of the ALSPEK MQ device is that as the number of particles and inclusions in the melt increases so the flow through the filter will become more restricted. This apparatus is still under foundry trials before start to be widely used in daily quality control.

Conclusions

The quality of cast products in aluminum casting plants directly depends on the quality of molten metal from which the products are cast. Comprehensive understanding of the melt quality is of the vital importance for the control and prediction of actual casting characteristics. This paper represents a review of the most common tools used in aluminum casting plants in melt quality control such as: (i) thermal (cooling curve) analysis, (ii) reduced pressure test, (iii) K-mold (iv), Tatur test, (v) spiral test and (vi) Prefil or PoDFA apparatus. Two new equipments recently developed by Foseco

Company; AlspekH for on-line measurement of hydrogen solubility in aluminum melt and Alspek MQ for melt cleanliness assessment are also presented.

References

- [1] M. J. Lessiter and W.M. Rasmussen; To pour or not to Pour The Dilemma of Assessing your Aluminum Melt's Cleanliness, *Moder Casting*, February 1996, pp. 45-48.
- [2] W. La-Orchan, Quantification of the reduced pressure test, PhD Thesis McGill University, Montreal, Canada, 1994.
- [3] D. Dispinar, Determination of the melt quality of aluminum and its alloys, PhD, University of Birmingham, UK, January 2005.
- [4] M. Di Sabatino, F. Syvertsen, L. Arnberg, and A. Nordmark, An improved method for fluidity measurement by gravity casting of spirals in sand moulds, *International Journal of Cast Metals Research*, vol.18, 59-62, 2005.
- [5] K. Bangyikhan, Effects of oxide film, Fe-rich phase, Porosity and their interactions on the tensile properties of cast AlSiMg alloys.
- [6] M. B. Djurdjevic, G. Byczynski, J. Pavlovic, H. Stieler: "Quantification of the Strontium Impact on the Solidification Path of the Al-Si-Cu Alloys Using Thermal Analysis Technique", *Praktische Metallographie*, No 49, 2009, pp. 137-152.
- [7] M. B. Djurdjevic, J. H. Sokolowski and H. Jiang, "On-Line Prediction of the Aluminum-Silicon Eutectic Modification Level Using Thermal Analysis", *Materials Characterization*, 2000, v. 45, 31-38.
- [8] D. Gloria, Control of grain refinement of Al-Si alloys by thermal analysis, PhD Thesis McGill University, Montreal, Canada, 1999.
- [9] S. Kitaoka, Evaluation of the melt cleanliness by K mold test, *Light Metals 2001*, 40th Annual Conference of Metallurgists of CIM (COM 2001), August 26-29, 2001, Toronto, Ontario, pp.13-24 (ISBN 1-894475-12-7).
- [10] [http://library.abb.com/global/scot/scot205.nsf/veritydisplay/629ca5481dc935388525761800526c29/\\$File/PoDFA%20Brochure.pdf](http://library.abb.com/global/scot/scot205.nsf/veritydisplay/629ca5481dc935388525761800526c29/$File/PoDFA%20Brochure.pdf)
- [11] R. Gallo, Cleaner aluminum melts in foundries: A critical review and update, *AFS Transactions 2008*, Schaumburg IL USA, Paper 08_094(02) pp. 1 – 26.
- [12] D.V. Neff, Improving die casting melt quality and casting results with melt quality analysis and filtration, <http://www.pyrotek.info/documents/techpapers/Improving%20Die%20Casting%20Melt%20Quality.pdf>.
- [13] P. G. Enright, I. R. Hughes, J. Pickering, A. Simard, and J. Proulx, Characterisation of Molten Metal Quality Using the Pressure Filtration Technique, [http://library.abb.com/global/scot/scot205.nsf/veritydisplay/d6d22d7550b631dd8525761800538bc0/\\$File/Characterisation%20of%20Molten%20Quality.pdf](http://library.abb.com/global/scot/scot205.nsf/veritydisplay/d6d22d7550b631dd8525761800538bc0/$File/Characterisation%20of%20Molten%20Quality.pdf)
- [14] www.eaa.net/ea/education/TALAT/lectures/3205.pdf
- [15] www.foseco.de/uk/products.../ALSPEK_H_e_final.pdf